

UV Master

Prevent You Getting UV Over-Exposure

Instruction Manual

1

1.0 Introduction

Thank you for purchasing this model. Your Watch includes 5 functional modes. They are the Current Time Mode, UV Index Mode, Daily Alarm Mode, Chronograph Mode and Timer Mode.

This Watch equipped with an UV sensor that measures UV radiation in terms of UV index. This model also includes 2 UV index alarms. In addition to the UV sensing, this model also included current time, daily alarm, chronograph and timer functions.

Your Watch is carefully designed and produced, in order to utilize this feature of your Watch, it is advisable to use the Watch in conformity with the below notes:

- Read this manual before using the Watch.
- Avoid exposing your Watch to extreme conditions for an unreasonable time.
- Avoid rough use or severe impacts to your Watch.
- Store your Watch in a dry place when it is not in use.

It is recommended to have the battery replacement done by a certified service agency as this practice will maintain the water resistance standard on your Watch.

Clean your Watch occasionally with a soft moistened cloth. DO NOT expose the Watch to strong chemicals such as gasoline and alcohol, as they will damage your Watch.

WARNING

DO NOT use this Watch for commercial or professional purpose.

Make sure that you fully understand the functions and limitations of this Watch before using it.

Always compare the UV reading with the one broadcasted by local weather station.

Excessive exposure to UV radiation could cause fatal harm to a human body, always follow the 'Basic Sun Protection Messages' by the World Health Organization when you go out in the Sun.

2

2.0 Parts and Its Functions

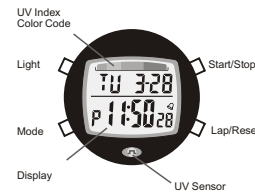

Note: The operations of the buttons are summarized in the adjacent paragraphs. However, for the detail operations, please check the coming chapters.

[mode] Button

Press the button to select among the 5 function modes. In function modes: Press and hold the button to select setting display. During setting displays: Press the button to select among different setting items. Press and hold the button to exit setting sequence.

[start/stop] Button

In Current Time Mode: Press the button to select between the Date Display and UV Index Display. In Daily Alarm Mode: Press the button to select between ON and OFF the daily alarm. In Chronograph Mode and Timer Mode: Press the button to start/stop the counting. In setting displays: Press the button to scroll through the setting.

[lap/reset] Button

In Daily Alarm Mode: Press the button to select between ON and OFF of the hourly chime. In Chronograph Mode: When counting, press the button to select the Lap time display. When stop-counting, press the button to reset to zero display. In Timer Mode: When stop-counting, press the button to reset the timer to target time. In setting displays: Press the button to scroll the setting.

[light] Button

In any mode, press the button once to turn ON the EL back light for about 3 seconds.

3

3.0 Functional Mode and Functional Display

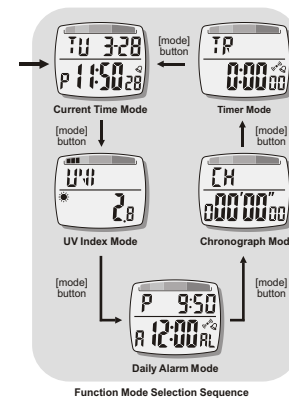

The Watch includes 5 functional modes. They are the Normal Time Mode, UV Index Mode, Daily Alarm Mode, Chronograph Mode and Timer Mode.

Every function mode may include one or more than one function display, it provides supplementary features to the corresponding function mode.

To Switch among the 5 Functional Modes

To select among the 5 function modes, press the [mode] button following the adjacent figure.

To Switch among the Function Displays

To select among the function displays, check the coming chapters for the detail on how to switch among different function displays.

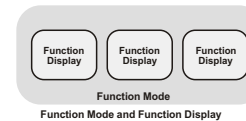

4

4.0 Current Time Mode - Date Display & UV Index Display

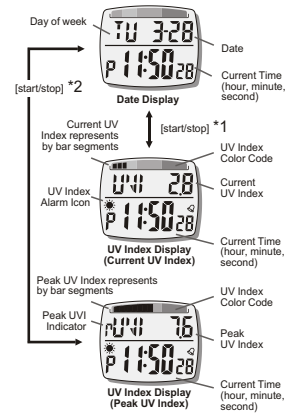

The Current Time Mode includes two function displays. They are the Date Display and UV Index Display.

Date Display

The day of week and date appear on the upper row of the display. The current time (hour, minute, second) appears on the lower row of the display.

UV Index Display

Either the Current UV Index info or Peak UV Index info appears on the upper row.

Note 1: The Current UV Index info will appear in this display if the Current UV Index has been selected in the UV Index Mode.

Note 2: The Peak UV Index info will appear in this display if the Peak UV Index has been selected in the UV Index Mode.

Check the coming '5.4 Current & Peak UV Index Display' Section for more detail on how to select between Current UV Index and Peak UV Index. The UV Index Alarm Indicator and the Current Time appear on the lower row of the display.

To Select between the Date Display and UV Index Display

Press the [start/stop] button once to select between the Date Display and UV Index Display.

5

5.0 UV Index Mode - What Does the UV Index Mean

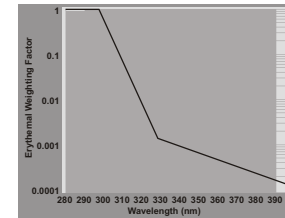

Erythral Action Spectrum
Source: The International Commission on Illumination

The UV Index is a measure of the solar UV (ultraviolet) intensity at the Earth's surface relevant to the effect on human skin.

The skin-damaging UV radiation is governed by the erythral action spectrum, the black line in the adjacent figure.

This spectrum has been adopted by the International Commission on Illumination (CIE) to represent the average skin response over the solar UV spectrum.

Source:

World Health Organization
National Oceanic Atmospheric Administration
Hong Kong Observatory

Further information (28 August 2003):

- 1) www.who.int/peh-uv/uv_radiation.htm
- 2) www.cpc.ncep.noaa.gov/products/stratosphere/uv_index/uv_information.html
- 3) www.hko.gov.hk/wxinfo/uvindex/english/uvbinfo.htm

7

4.1 Current Time Mode - To Set the Current Time

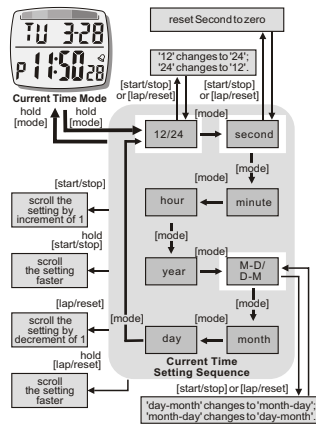

To set the current time and date, and their display formats, press and hold the [mode] button for about 2 seconds to select the setting display.

When the '12Hr' or '24Hr' is flashing, press the [start/stop] or [lap/reset] button to switch between '12Hr' (12 hour format) and '24Hr' (24 hour format).

When the 'second' flashes on the display, press [start/stop] or [lap/reset] button to reset the second to zero.

If one of the setting items (minute, hour, year, month, day) is flashing, press the [start/stop] or [lap/reset] button to scroll the setting (hold down the button to scroll the setting faster).

When the 'M-D' or 'D-M' is flashing, press the [start/stop] or [lap/reset] button to switch between 'M-D' (month-day) and 'D-M' (day-month).

When the above settings are finished, press and hold the [mode] button for about 2 seconds to exit the setting sequence.

The setting display will change to Current Time Mode automatically if no key-stroke has been activated for about 3 minutes.

6

5.1 UV Index Mode - UV Index Range, Exposure Category and Color Code

UV Index Range	Exposure Category	Color Code
0 - 2	Low	Green
3 - 5	Moderate	Yellow
6 - 7	High	Orange
8 - 10	Very High	Red
11 +	Extreme	Purple

UV Radiation Exposure Categories
Source: World Health Organization

As categorized by the World Health Organization, the UV Index ranges between 0 and 11+. Each UV index is matched with an exposure category and color code. Check the adjacent table for more detail on UV index range, exposure category and color code.

The lower the UV Index, the lower the UV exposure category, the less likely the damage to our body, while the higher the index, the higher the UV exposure category, the more likely the damage to our body.

This Watch exhibits UV Index. User can make use of the exhibited UV Index to cross-check his/her exposure level, and hence to taking the appropriate protections to safeguard his/her body from the potential harms of UV radiation.

Source:

World Health Organization
National Oceanic Atmospheric Administration
Hong Kong Observatory

Further information (28 August 2003):

- 1) www.who.int/peh-uv/uv_radiation.htm
- 2) www.cpc.ncep.noaa.gov/products/stratosphere/uv_index/uv_information.html
- 3) www.hko.gov.hk/wxinfo/uvindex/english/uvbinfo.htm

8

5.2 UV Index Mode - Basic Sun Protection Messages

- | | |
|---|--|
| 1. Check The Latest UV Index | 2. Stay Away From The Sun If the UV Index is Very High |
| 3. Wear Long-sleeved and Loose-fitting Clothing | 4. Wear a Broad Brim Hat or Use An Umbrella |
| 5. Wear UV Blocking Sunglasses | 6. Apply UV Blocking Lotion Regularly |
| 7. Avoid Tanning Beds | 8. Protect Babies and Young Child |

When you go out in the sun, World Health Organization (WHO) suggests taking the following protective measures against UV radiation:

- 1) Limit exposure during midday hours.
- 2) Seek shade.
- 3) Wear protective clothing.
- 4) Wear a broad-brimmed hat to protect the eyes, face and neck.
- 5) Protect the eyes with wrap-around-design sunglasses or sunglasses with side panels.
- 6) Use and reapply broad-spectrum sunscreen of sun protection factor (SPF) 15+ liberally.
- 7) Avoid tanning beds.
- 8) Protect babies and young children.

Source:

World Health Organization
Hong Kong Observatory

Further information (28-08-2003):

- 1) www.who.int/peh-uv/uvindex.htm
- 2) www.hko.gov.hk/wxinfo/uvindex/english/euvtoday.htm

9

5.4 UV Index Mode - Current & Peak UV Index Display

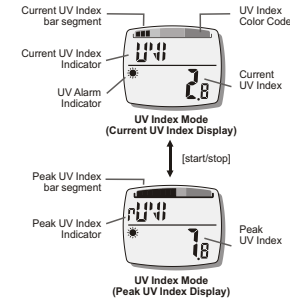

The UV Index Mode includes two functional displays. They are the Current UV Index Display and Peak UV Index Display.

Current UV Index Display

The Current UV Index Bar Segment displays on the upper row of the display. The Current UV Index and UV Index Alarm Indicator display on the lower row of the display.

Note: When this display has been selected, and then the watch returns to Current Time Mode: the Current UV Index Bar Segment and Current UV Index will display if UV Index Display is selected.

Peak UV Index Display

The Peak UV Index Bar Segment appears on the upper row of the display. The Peak UV Index and the UV Index Alarm Indicator appear on the lower row of the display.

Note: When this display has been selected, and then the watch returns to Current Time Mode: the Peak UV Index Bar Segment and Peak UV Index will display if UV Index Display is selected.

To Select between the Current and Peak UV Index Display

Press the [start/stop] button once to select between the Current UV Index Display and Peak UV Index Display.

11

5.3 UV Index Mode - How UV is Sensing

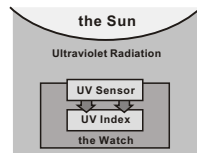

How UV is Sensing

This Watch uses a built-in UV sensor to detect ambient Ultraviolet radiation which is then converted to UV Index.

The UV Sensor is the small spot that is located on the lower part of the dial. Check the previous '2.0 Parts and Its Functions' Section for the detail on the location of the UV Sensor.

Notes to UV Measurement

To make an accurate result, employ the following steps when taking a UV measurement:

- 1) Position the UV Sensor directly to the source of radiation, for example the Sun.
- 2) Avoid sheltering the UV Sensor unintentionally.
- 3) Rotate the Watch slowly and search for the maximum reading.

4) Clean the lens of the Watch with a soft cloth before the measurement, this practice allows NO dirt or dust sheltering the UV sensor. During the first five minutes of UV Index Mode, the Watch needs two seconds to get a reading.

After the first five minutes of UV Index Mode, the Watch needs 10 seconds to get a reading.

- | | |
|---|---|
| 1. Position the UV Sensor directly to the source | 2. Avoid Shelter the UV Sensor Unintentionally |
| 3. Rotate the Watch Slowly and Search for Maximum Reading | 4. Clean the lens of the Watch with a Soft Cloth before the measurement |

Notes to UV Measurement

10

5.5 UV Index Mode - How to Read UV Index Bar Segment & Color Code

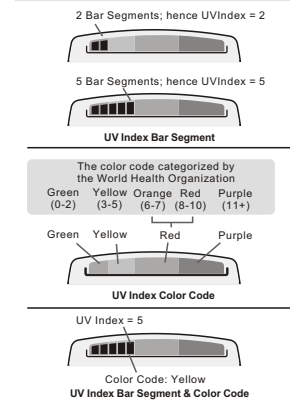

UV Index Bar Segment

To provide user a quick concept about the Current and Peak UV Indexes, this Watch exhibits them by displaying a different number of bar segments on the upper row of the display.

Whether the Current or Peak UV Index Bar Segment appear on the upper row of the display, one exhibited bar segment equals one UV Index. For example, if there are 5 bar segments displayed on the upper row of the display, the UV Index is 5.

UV Index Color Code

As categorized by the World Health Organization, each UV index is matched with a color code. Check the previous '5.1 UV Index Range, Exposure Category and Color Code' Section for more detail on the Color Code.

To provide user a quick concept about the color code of the current and peak UV index, this Watch also printed green, yellow, red (stand for orange and red) and purple color on the display.

Read the color code of a UV index by checking the color background of the right-most exhibited UV index bar segment. For example, if there are 5 bar segments displayed on the upper row of the display, the color code is Yellow.

12

5.6 UV Index Mode - UV Index Alarm

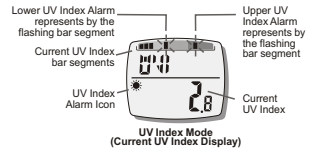

UV Index Mode (Current UV Index Display)

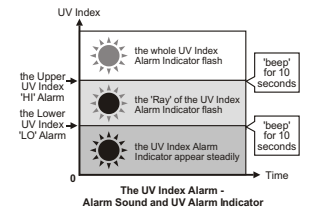

The UV Index Alarm - Alarm Sound and UV Alarm Indicator

To prevent user getting UV over-exposure, this Watch includes two UV Index Alarms. They are the Upper UV Index Alarm and Lower UV Index Alarm.

These UV Index Alarms can be set separately by the user. Check the coming '5.7 Setting the Upper and Lower UV Index Alarms' Section for more detail on how to set the UV Index Alarms.

When one UV Index Alarm has been set, the corresponding bar segment will be flashing on the display.

UV Index Alarm Sound

In all of the modes: Whenever the Current UV Index is equal to or larger than the Upper or Lower UV Index Alarm, the Watch starts beeping for about 10 seconds.

UV Index Alarm Indicator

In all of the UV Index displaying modes: When the Current UV Index equal to or larger than the Lower UV Index Alarm, the 'Rays' of the UV Index Alarm Indicator starts flashing on the display.

In all of the UV Index displaying mode: When the Current UV Index equal to or larger than the Upper UV Index Alarm, the whole UV Index Alarm Indicator starts flashing on the display.

13

5.8 UV Index Mode - Precautions to UV Index Calibration

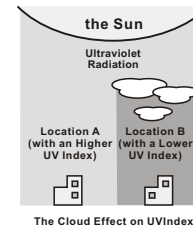
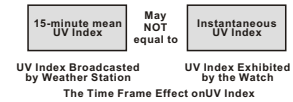

The Watch's UV sensor has been calibrated in the factory. The most possible cause for deviation is the Ozone thickness, difference between the place of use and calibration of the Watch. For normal usage, you should not need to calibrate the Watch again. DO NOT attempt to calibrate the UV index unless you have the following items to determine the Calibration Factor (CAL):

- 1) Standard UV generator or
 - 2) Correct immediate local UV Index
- DO NOT use the UV Index broadcasted by the local weather station as the correct UV index, it may NOT the correct one at your place when you calibrating your Watch, this is because:
- 1) Weather stations usually broadcast the 15-minute mean UV Index to public. It is different from the instantaneous UV radiation that your Watch is now sensing.
 - 2) Cloud condition affects UV Index. Hence, the UV Index at your location may not be identical to the one at weather station if the two cloud conditions are not alike.

Check the coming '5.9 To Determine the Calibration Factor (CAL)' Sections for more detail on how to determine CAL.

15

5.7 UV Index Mode - Setting the Upper and Lower UV Index Alarms

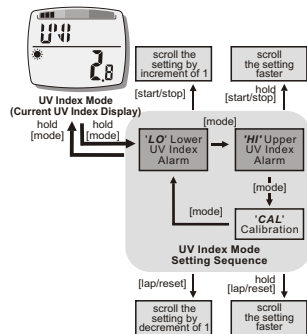

To set the Upper, Lower UV Index Alarm and calibrate the UV Index, press and hold the [mode] button for about 2 seconds to select the setting display.

When the 'LO' indicator appear: Press the [start/stop] or [lap/reset] button to select the Lower UV Index Alarm setting among 0 to 25 (select '-' to turn OFF the alarm) by scrolling of 1 (hold down the button to scroll the setting faster).

When the 'HI' indicator appear: Press the [start/stop] or [lap/reset] button to select the Upper UV Index Alarm setting among 0 to 25 (select '-' to turn OFF the alarm) by scrolling of 1 (hold down the button to scroll the setting faster).

Note: To control the UV exposure by a two-level alarm, set a smaller value (for example: 6) for the Lower UV Index Alarm, and set a larger value (for example: 10) for the Upper Index Alarm.

When the above settings finished, either press and hold the [mode] button for about 2 seconds to exit the setting sequence or press the [mode] button once to calibrate the UV Index.

To calibrate the UV Index, check the coming '5.8 Precautions to UV Index Calibration', '5.9 To Determine the Calibration Factor (CAL)' and '5.10 Calibrating the UV Index' Sections for more detail on the UV Index Calibration.

14

5.9 UV Index Mode - To Determine the Calibration Factor (CAL)

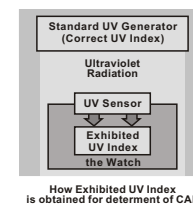

Determine the CAL by using the following rules:

- 1) Correct UV Index: The UV index produced by a standard UV generator or other similar means.
- 2) Exhibited UV Index: The UV Index exhibited by the Watch when it is exposed to the previous standard UV generator.
- 3) ADJ: The percentage change of UV Index. Hence $ADJ = ((\text{Correct UV Index} - \text{Exhibited UV Index}) / \text{Exhibited UV Index}) \times 100\%$
- 4) Calibration Factor (CAL): The value that to be selected for the calibration. $CAL = 25 + ADJ$.

Example 1: To adjust the UV Index from 4.8 (Exhibited UV index) to 4.0 (Correct UV Index).

$$ADJ = ((4.0 - 4.8) / 4.8) \times 100 = -17;$$

$$CAL = 25 + ADJ;$$

$$\text{Hence, } CAL = 25 - 17 = 8.$$

Example 2: To adjust the UV Index from 7.8 (Exhibited UV index) to 8.0 (Correct UV Index).

$$ADJ = ((8.0 - 7.8) / 7.8) \times 100 = 3;$$

$$CAL = 25 + ADJ;$$

$$\text{Hence, } CAL = 25 + 3 = 28.$$

To resume the Watch to its original setting for sensing UV radiation, select the default value (25) as the CAL during the calibration.

16

5.10 UV Index Mode - Calibrating the UV Index

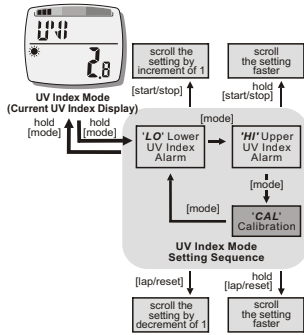

To Calibrate the UV Index

When the settings of the previous '5.7 Setting the Upper and Lower UV Index Alarms' Section are finished, press the [mode] button once to calibrate the UV Index.

When the 'CAL' indicator appears, press the [start/stop] or [lap/reset] button to select the pre-determined CAL between 0 to 50 by scrolling of 1 (hold down the button to scroll the setting faster). Check the previous '5.9 To Determine the Calibration Factor (CAL)' for more detail on how to determine the CAL.

When the above settings finished, press and hold the [mode] button for about 2 seconds to exit the setting sequence.

The setting display will change to UV Index Mode automatically if no key-stroke has been activated for about 3 minutes.

17

6.1 Daily Alarm Mode - Setting the Daily Alarm Mode

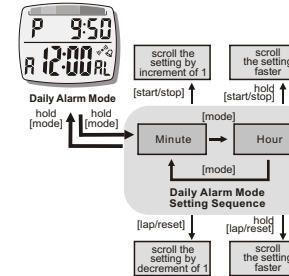

To set the Daily Alarm Time, press and hold the [mode] button to select the setting display.

When the 'minute' digits flash on the display, press the [start/stop] or [lap/reset] button to set the minute by scrolling of 1 (hold down the button to scroll the setting faster).

When the 'hour' digits flash on the display, press the [start/stop] or [lap/reset] button to set the hour by scrolling of 1 (hold down the button to scroll the setting faster).

When the setting is finished, press and hold the [mode] button to exit the setting sequence.

The setting display will change to Daily Alarm Mode automatically if no key-stroke has been activated for about 3 minutes.

Daily Alarm Sound

When the daily alarm is ON, the watch starts beeping at the alarm time for about 30 seconds.

When the beeps sounds, it can be stopped prematurely by pressing one of the buttons, except the [light] button.

19

6.0 Daily Alarm Mode - Daily Alarm Mode

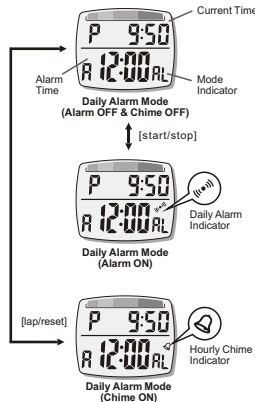

This Watch includes a daily alarm for user's convenience. The daily alarm can be set by the user.

Check the coming '6.1 Setting the Daily Alarm Mode' Section for more detail on how to set the Daily Alarm Mode.

The Daily Alarm Display

The Current Time (hours, minutes) shows on the upper row of the display.

The Alarm Time (hours, minutes) shows on the lower row of the display.

To Select between ON and OFF the Daily Alarm

Press the [start/stop] button once to set between ON and OFF the Daily Alarm. When the Daily Alarm Indicator '🔔', appears, the daily alarm is ON (the watch starts beeping at the alarm time for about 30 seconds).

To Select between ON and OFF for the Hourly Chime

Press the [lap/reset] button once to select between ON and OFF the hourly chime. When the Hourly Chime Indicator '🔔', appears, the hourly chime is ON (the Watch will beep once on the hour).

18

7.0 Chronograph Mode - Chronograph Mode

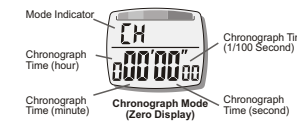

This Watch includes a Chronograph Mode, it can measure 3 different types period of time:

- 1) Elapsed time,
- 2) Accumulative elapsed time, and
- 3) Lap time (1 lap only)

Chronograph Display

The display shows the 'Zero' display, if the Watch or the chronograph has been reset.

The Chronograph Mode Indicator exhibits on the upper row of the display. The chronograph time (hours, minutes, seconds and 1/100 second) exhibits on the lower row of the display.

The maximum counting range of the chronograph is 9 hours, 59 minutes and 59.99 seconds.

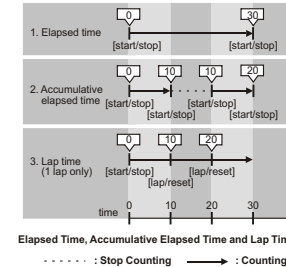

20

7.1 Chronograph Mode - Using the Chronograph

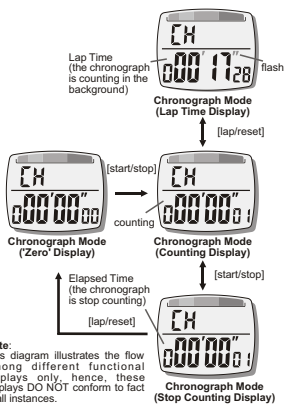

In 'Zero' Display, press the [start/stop] button once to start the counting. When it is counting, press the [start/stop] button once again to stop the counting, and the elapsed time of which the chronograph is counting will appear.

When the elapsed time is displaying, repeat the above mentioned key operations to get the accumulative elapsed time or press the [lap/reset] button to reset the chronograph (ready for a new counting). Check the below 'To Reset the Chronograph' Section for more detail on how to reset the chronograph.

To Get the Lap Time

When the chronograph is counting in the previous operations, press the [lap/reset] button to get the Lap Time Display (the 'L' and 'H' start flashing). When the Lap Time is displaying, the chronograph is counting in the background.

In Lap Time Display, press the [lap/reset] button once to return to the Counting Display. When the Counting Display return, press the [lap/reset] button at any designated moment to get a new lap time (the previous lap time will be erased).

To Reset the Chronograph

To reset the chronograph to 'Zero' Display, press the [lap/reset] button once when the chronograph is stopped counting.

8.1 Timer Mode - Setting the Timer Mode

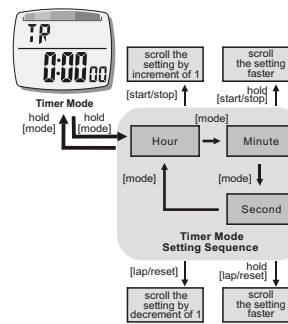

To Set the Timer Mode

To set the target time for the Timer Mode, press and hold the [mode] button for about 2 seconds to select the setting display.

When the 'hour' digits flash on the display, press the [start/stop] or [lap/reset] button to set the hour by scrolling of 1 (hold down the button to scroll the setting faster).

When the 'minute' digits flash on the display, press the [start/stop] or [lap/reset] button to set the minute by scrolling of 1 (hold down the button to scroll the setting faster).

When the 'second' digits flash on the display, press the [start/stop] or [lap/reset] button to set the second by scrolling of 1 (hold down the button to scroll the setting faster).

When the setting is finished, press and hold the [mode] button to exit the setting sequence.

The setting display will change to Timer Mode automatically if no key-stroke has been activated for about 3 minutes.

8.0 Timer Mode - Timer Mode

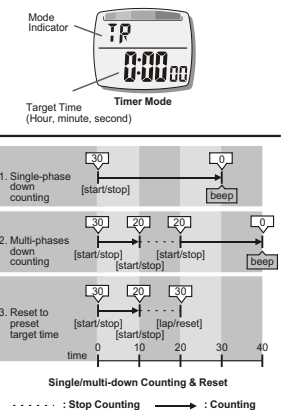

This Watch includes a countdown timer for timekeeping a fixed period of time (target time).

The Target Time

The target time is the time which the timer start down-counting from. The target time can be set by the user, and its setting limit is 23 hours, 59 minutes 59 seconds.

Check the coming '8.1 Setting the Timer Mode' Section for more detail on how to set the Timer Mode - Target Time.

Timer Display

The Timer Mode Indicator exhibits on the upper row of the display.

The target time (hours, minutes and seconds) exhibits on the lower row of the display.

8.2 Timer Mode - Using the Timer

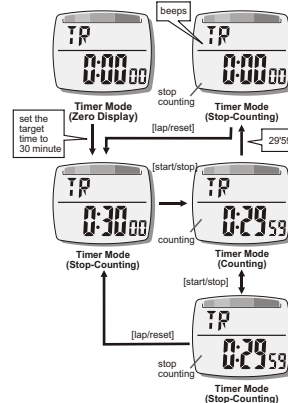

If a target time has been set (for example 30 minutes), press the [start/stop] button once to start the countdown. When it is counting, press the [start/stop] button once to stop the counting.

As long as the timer is counting, the countdown time will be displaying on the display continuously.

To Reset the Timer

To reset the timer to the preset target time before counting to zero, press the [lap/reset] button once when the timer is stopped.

To count from a new target time, set a new value for the target time. Check the previous '8.1 Setting the Timer Mode' Section for more detail on how to set the Timer Mode.

Timer Alarm Sound

When it counts to the last 5 seconds, the Watch will beep once for every second. When it is zero, the Watch will beep for about 10 seconds.

During this 10 seconds beep sound, it can be stopped prematurely by pressing one of the buttons except the [light] button.

Note: The adjacent diagram illustrates the flow among different functional displays only, hence, these displays DO NOT conform to fact in all instances.

9.0 Specifications

Current Time Mode

Hour, minute and second
Month, day, day of week and year
12 / 24 hour format selectable
Month-day/Day-month selectable
Auto calendar from year 2000 to 2099
Hourly Chime on the hours

UV Index Mode

Display range (bar segment): 0 to 15
Measuring range(numeric): 0 to 25
Resolution (bar segment): 1 UV Index
Resolution (numeric): 0.1 UV Index
Alarm: 2 UV Index Alarms
Color Code: 4 colors (Green, Yellow, Red and Purple).

Daily Alarm Mode

Daily Alarm: 1 daily alarm
Alarm Duration: about 30 seconds

Chronograph Mode

Resolution: 1/100 second
Counting range: 9 hours, 59 minutes, 59.99 seconds
Measuring mode: Elapsed time, accumulative elapsed time and lap time (1 lap only)

Timer Mode

Resolution: 1 second
Setting limit: 23 hours, 59 minutes, 59 seconds
Alarm sound: One beep at the 5,4,3,2 and 1 second(s).
Alarm sound: 'Beep-beep-beep' at 0 second
Alarm duration: about 10 seconds.

Others

Electro-luminescent back light

25

10.0 Limited Liabilities

The Company is not liable for any damages caused by the product or the failure of the product to perform, including any loss of profits or savings, incidental damages, or consequential damages. There is no liability of the Company against any claim made by a third party or made by you on behalf of a third party. Even if you have advised the Company or an authorized representative of the Company of the possibility of any such damages, this limitation will still be in effect. This limitation of liability cannot be waived or amended by any person. This limitation is applicable under the condition that whether damages are sought, or a claim made, under the limited warranty as mentioned in this manual or as a tort claim (including negligence and strict product liability), a contract claim, or any other claim.

The Company disclaims all warranties that are not stated in the express limited warranties in this manual. We makes no other express or implied warranties, including any implied warranties of merchantability and fitness for a particular purpose. All implied warranties that maybe imposed by law are limited to the terms of this limitation and the limited warranty.

Some countries do not allow the exclusion of incidental or consequential damages or a limitation on how an implied warranty lasts. Some exclusion or limitation of this limited warranty may not apply to you. This limited warranty gives you specific legal rights and you may have other rights vary from country to country.

26

11.0 Limited Warranty

The Company warrant this unit to be free from defects in material and/or workmanship for a 1-year period beginning from the date of purchase. This warranty does not cover second-hand ownership or products that are purchased for sale or lease to another. This warranty does not cover damage resulting from acts of God, lightning accident, misuse, improper installation or operation, or unauthorized repair or alteration.

If this unit has become defective within the first year of purchase, return it to the retailer where it is obtained (with all of the original packing materials and parts) for reconditioning or replacement. Whether or not to replace or recondition the unit would be decided by the retailer. The replaced / reconditioned unit will be warranted for a period of 90 days or the remainder of the original one year period, whichever is longer.

To obtain warranty service on your Watch, you must provide proof of date of purchase. We strongly recommend that you keep your sales receipt and all of the packing materials in order to take advantage of your Watch's limited warranty. Include all accessories and operational manual when returning to the retailer. A brief description of the defect and a copy of your sales receipt.

27

UV Master
Prevent You Getting UV Over-Exposure

28